

BURGLAR, BALLISTIC, BLAST & FIRE RESISTANT SYSTEMS



PRESIDENTIAL PAVILLION,  
CONGO AIRPORT  
Arch. LUFTHANSA CONSULTING  
BALLISTIC RESISTANT CLASS BR7



## PREMIUM PARTNER FOR SAFETY GLAZING SYSTEMS

GLASSCON GmbH is a leading engineering and contracting company operating globally through subsidiaries and local partners. We specialize in bespoke façade solutions providing a complete line of custom architectural products to meet complex designs for glazing systems and curtain walling.

GLASSCON offers solutions against a wide range of threat levels as part of our innovative security product range. Our solutions have been designed to deliver high-level protection against manual attack, ballistic, blast and fire threats and have been independently tested and certified by accredited testing institutes in accordance with the current European (EN) standards.



## SAFETY AT THE TOP OF THE LIST

---

The world has changed.

As safety concerns continue to rise, there's a growing demand for protection of people and property in both commercial and residential buildings.

Managing threat scenarios requires simultaneous protection against forced entry, ballistic and blast attacks as well as fire hazards.









## BURGLAR PROOF GLAZING SYSTEMS

Burglar resistant systems have been certified in accordance with the EN 1627:2011 and EN 356:2000 standards. GLASSCON offers a range of solutions for doors, windows and curtain walls designed to resist actions of force by manual attack.

Test methods for classification of the burglar resistance of security frame and glazing include static and load tests as well as manual attacks, which depending on the attacking time and force to which the samples are subjected, obtain classifications from RC1 to RC6, P1A to P5A and P6B to P8B.

### Key Features

-  Internal or external use
-  Increased mechanical strength and durability
-  Slim sightlines and large expanses of glass
-  Excellent anti-UV characteristics
-  CE marking
-  Options: thermal insulation, soundproofing, fire protection

### Applicable standards & classification levels

#### EN 1627: 2011

Pedestrian doorsets, windows, curtain walling, grilles and shutters. Burglar resistance. Requirements and classification.

#### EN 356: 2000

Glass in building. Security glazing. Testing and classification of resistance against manual attack.

### Classification Buglar proof glazing system

#### Class RC1

Opportunistic burglars will try to break windows or doors using physical force, kicking, using their shoulders, levering or pulling outward.

#### Class RC3

Burglars will try to break open, closed and secured windows or doors with RC2 tool plus additional use of a second screwdriver and a crowbar.

#### Class RC5

Experienced burglars also use electric tools, such as a drill, a compass or reciprocating saw and an angle grinder with a maximum disc diameter of 125 mm.

#### Class RC2

Opportunistic burglars will try to break open, closed and secured windows or doors with the additional use of simple tools, such as a screwdriver or pliers.

#### Class RC4

Experienced burglars also use saws and impact tools, such as an axe, a chisel, a hammer or a battery-powered drill.

#### Class RC6

Experienced burglars also use electric power tools, such as a drill, a compass or reciprocating saw and an angle grinder with a maximum disc diameter of 250 mm.

### The Lower Resistance Level (Anti-Vandalism)

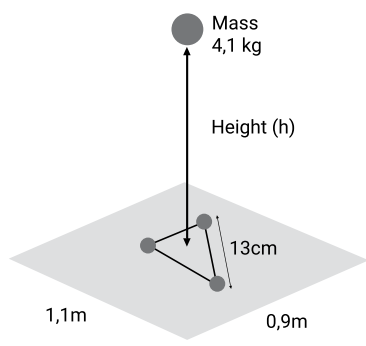

| BALL DROP TEST |               |                 |                        |
|----------------|---------------|-----------------|------------------------|
| Class          | No of Strikes | Drop height (m) | Impact Energy (Joules) |
| P1A            | 3             | 1.5             | 181                    |
| P2A            | 3             | 3               | 362                    |
| P3A            | 3             | 6               | 724                    |
| P4A            | 3             | 9               | 1.086                  |
| P5A            | 9             | 9               | 3.258                  |

Ball weight 4,1Kg  
Requirement: To pass test, the ball must not penetrate the glass

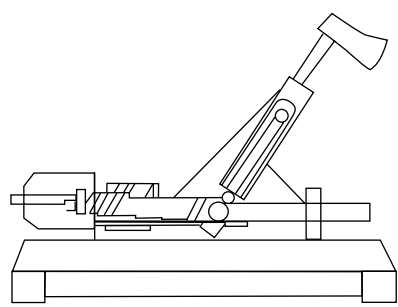

### The Higher Resistance Level (Intrusion Deterrence)

| HAMMER AND AXE TEST |                    |
|---------------------|--------------------|
| Class               | Number of blows    |
| P6B                 | 30 to 50 blows     |
| P7B                 | 51 to 70 blows     |
| P8B                 | More than 70 blows |

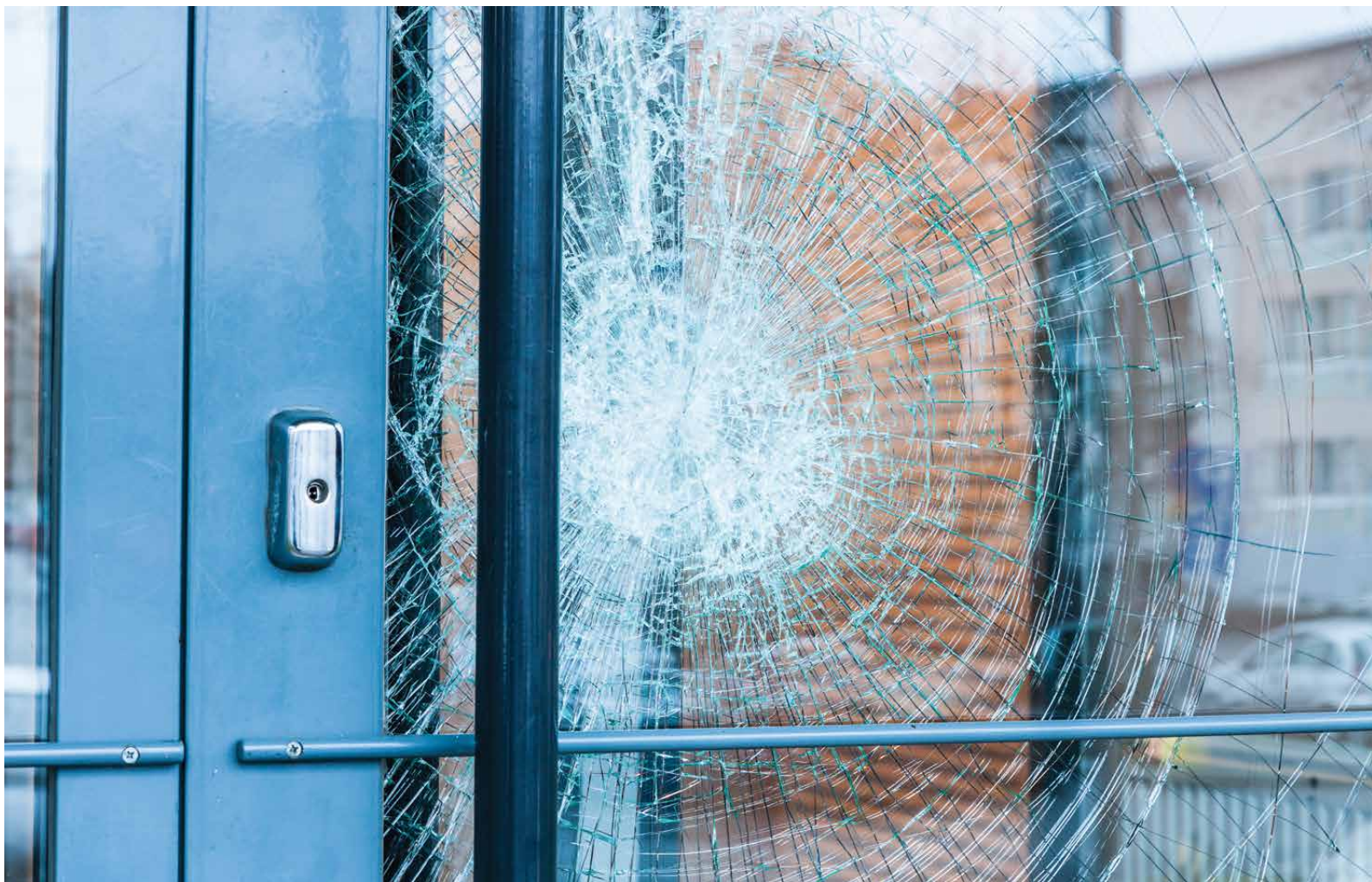







## BALLISTIC RESISTANT - BULLET PROOF GLAZING SYSTEMS

Bullet resistant systems have been certified in accordance with the EN 1063:2000 and EN 1522:1999 standards. GLASSCON offers a range of bulletproof solutions for doors, windows and curtain walls that meet the requirements of protection from attacks by handguns, rifles and shotguns.

Test methods for classification of the bullet resistance of glass and glass/plastic composites include firing tests which, depending on the caliber of the weapon used and the appearance or not of splinters on the protected part, obtain different classifications, from FB1 to FB7, BR1 to BR7 and SG1 to SG2.

### Key Features

|                                                                                     |                                                             |
|-------------------------------------------------------------------------------------|-------------------------------------------------------------|
|    | Internal or external use                                    |
|    | Increased mechanical strength and durability                |
|    | Slim sightlines and large expanses of glass                 |
|    | Excellent anti-UV characteristics                           |
|    | CE marking                                                  |
|  | Options: thermal insulation, soundproofing, fire protection |

### Applicable standards & classification levels

#### EN 1063:2000

Glass in building. Security glazing. Testing and classification of resistance against bullet attack

#### EN 1522:1999

Windows, doors, curtain walling, shutters and blinds. Bullet resistance. Requirements and classification

### Classification Ballistic resistant - Bullet proof glazing systems

| Safety System Class | Glass Level | Gun           |                   | Bullet      |            | Test Conditions    |                    |                        |
|---------------------|-------------|---------------|-------------------|-------------|------------|--------------------|--------------------|------------------------|
|                     |             | Type          | Caliber           | Type        | Weight (g) | Shooting Range (m) | Bullet Speed (m/s) | No. of Shots at 120 mm |
| FB1                 | BR 1        | Hand Gun      | .22 LR            | LB/RN       | 2.6        | 10                 | 360 ±10            | 3                      |
| FB2                 | BR 2        |               | 9X19 Para         | FJ/SC       | 8.0        | 5                  | 400 ±10            | 3                      |
| FB3                 | BR 3        |               | .357 Magnum       | FJ/CB/SC    | 10.2       | 5                  | 430 ±10            | 3                      |
| FB4                 | BR 4        |               | .44 Magnum        | FJ/FN/SC    | 15.6       | 5                  | 440 ±10            | 3                      |
| FB5                 | BR 5        | Assault Rifle | 5.56X45 mm SS 109 | FJ/PB/SCP1  | 4.0        | 10                 | 950 ±10            | 3                      |
| FB6                 | BR 6        |               | 7.62 X 51 mm      | FJ/PB/SC    | 9.5        | 10                 | 820 ±10            | 3                      |
| FB7                 | BR 7        |               | 7.62 X 5 mm (AP)  | FJ/PB/HC1   | 9.8        | 10                 | 830 ±10            | 3                      |
|                     | SG 1        | Shotgun       | 12/70             | Brenneke LB | 15.6       | 10                 | 420 ±10            | 1                      |
|                     | SG 2        |               | 12/70             | Brenneke LB | 15.6       | 10                 | 420 ±10            | 3                      |











## BLAST RESISTANT GLAZING SYSTEMS

Blast resistant systems have been certified in accordance with the EN 13123:2004 and EN 13541:2012 standards. GLASSCON offers a wide range of solutions for doors, windows and curtain walls against blast threat levels as part of our innovative security product range.

Test methods for classification of the blast resistance of frame and glazing include tests that submit samples to various pressure levels to obtain different classification levels from EXR1 to EXR5 and ER1 to ER4.

### Key Features

|                                                                                    |                                                             |
|------------------------------------------------------------------------------------|-------------------------------------------------------------|
|   | Internal or external use                                    |
|   | Increased mechanical strength and durability                |
|   | Slim sightlines and large expanses of glass                 |
|   | Excellent anti-UV characteristics                           |
|   | CE marking                                                  |
|  | Options: thermal insulation, soundproofing, fire protection |

### Applicable standards & classification levels

#### EN 13123-2:2004

Windows, doors, and shutters. Explosion resistance. Requirements and classification. Range test

#### EN 13541: 2012

Glass in building. Security glazing. Testing and classification of resistance against explosion pressure

### Classification Blast resistant safety systems

| Class | Load mass (kg) | Firing distance | Load height (mm) |
|-------|----------------|-----------------|------------------|
| EXR 1 | 3              | 5               | 500 ±50          |
| EXR 2 | 3              | 3               | 500 ±50          |
| EXR 3 | 12             | 5.5             | 800 ±50          |
| EXR 4 | 12             | 4               | 800 ±50          |
| EXR 5 | 20             | 4               | 800 ±50          |

### Classification Blast resistant glazing

| Class | Max pressure of reflected shock wave $P_v$ (kPa) | Specific positive impulse $I$ (kPa . ms) | Duration of positive pressure phase $t$ (ms) |
|-------|--------------------------------------------------|------------------------------------------|----------------------------------------------|
| ER 1  | $50 \leq P_v \leq 100$                           | $370 \leq I \leq 900$                    | $\geq 20$                                    |
| ER 2  | $100 \leq P_v \leq 150$                          | $900 \leq I \leq 1.500$                  | $\geq 20$                                    |
| ER 3  | $150 \leq P_v \leq 200$                          | $1.500 \leq I \leq 2.200$                | $\geq 20$                                    |
| ER 4  | $200 \leq P_v \leq 250$                          | $2.200 \leq I \leq 3.200$                | $\geq 20$                                    |









## FIRE RATED & SMOKE PROOF GLAZING SYSTEMS

Fire safety systems have been certified in accordance with the EN 1634-3:2004 and EN 13501-2:2003 standards. GLASSCON offers complete fire protection solutions for doors, windows and curtain walls with fire resistance and smoke proofing properties.

Test methods for classification of the fire resistance of doors and screening include fire tests that depending on the system's ability to withstand fire exposure and heat radiation to the non-fire side, obtain different classification levels from E to EI.

### Key Features

|                                                                                    |                                              |
|------------------------------------------------------------------------------------|----------------------------------------------|
|   | Internal or external use                     |
|   | Increased mechanical strength and durability |
|   | Slim sightlines and large expanses of glass  |
|   | Excellent anti-UV characteristics            |
|   | CE marking                                   |
|  | Options: thermal insulation, soundproofing   |

### Applicable standards & classification levels

#### EN 1634-3:2004

Fire resistance and smoke control tests for door and shutter assemblies, openable windows and elements of building hardware. Smoke control test for door and shutter assemblies

#### EN 13501-2: 2003

Fire classification of construction products and building elements. Classification using data from fire resistance tests, excluding ventilation services

### Classification Fire rated & smoke proof glazing systems

| Class         | E  |    |    |    |     | EW |    |    |    |     | EI |    |    |    |     |
|---------------|----|----|----|----|-----|----|----|----|----|-----|----|----|----|----|-----|
|               | 30 | 45 | 60 | 90 | 120 | 30 | 45 | 60 | 90 | 120 | 30 | 45 | 60 | 90 | 120 |
| Doors         | Δ• | Δ• | Δ• | Δ• | Δ•  | Δ• | Δ• | Δ• |    |     | Δ  | Δ  | Δ  | Δ  | Δ   |
| Sliding Doors |    |    |    |    |     |    |    |    |    |     | Δ  |    |    |    |     |
| Curtain walls | Δ• | Δ• | Δ• | Δ• |     | Δ• | Δ• | Δ• |    |     | Δ  | Δ  | Δ  | Δ  |     |
| Minimal frame |    |    |    |    |     |    |    |    |    |     | Δ  | Δ  |    |    |     |

#### E Class – Integrity

Prevents the spread of flames, toxic gases and smoke to the non-fire side.

Δ Fire rating

#### EW Class – Integrity & Low Radiation

Prevents the spread of flames and controls the heat radiation transmission to the non-fire side.

• Smoke resistant

#### EI Class – Integrity & Insulation

Prevents the spread of flames and the heat radiation transmission to the non-fire side.









GLASSCON GmbH

📍 Mergenthalerallee 77, 65760 Eschborn, Germany

☎ +49(0)61967889560

@ sales@glasscon.com

🌐 www.glasscon.com

Certified / Approved by:

