

Structural Glass Façade Technical Specifications

HUNGARIAN ACADEMY OF ARTS_STRUCTUREAL GLASS ATRIUM

GLASSCON - DO NOT COPY

Table of Contents

Revision History	2
1. Project Description (Structural Glass Atrium) / Introduction	4
1.1. Purpose of the Glass Atrium	4
1.2. FT 01_ front facade: Structural glass façade with glass fins/ mullions (vertical)	5
1.3. FT 02_ back facade: Structural glass façade with glass fins/ mullions (vertical)	6
1.4. External Door systems	7
1.5. General drawings.....	8
2. Pre-design (Static calculation)	12
2.1. Glass roof (GT4, GT5).....	12
2.2. Glass beams (GT1)	21
2.3. Curtain Wall (GT2, GT3).....	30
2.4. Glass Fins (GT1)	42
3. Details of contractor's responsibilities	49
3.1. Contractor Responsibility	49
3.2. Contractor's Scope of Work/ Submittals for Review	50
4. Glazing in general	51
5. References	53
6. Warranties	54

1. Project Description (Structural Glass Atrium) / Introduction

1.1. Purpose of the Glass Atrium

The purpose of the glass atrium is to seal the building against wind, water, and driving rain, and to provide a thermal insulated shell. The glass atrium will contain two (2) facades with continuous glass roof and several types of structural glass panels, glass fins and glass beams.

The contractor shall provide final structural engineering analysis, planning, fabrication, delivery and installation of façade units to be provided as per the contract, their delivery to the construction site, and their complete and ready-for-use assembly, and shall bring the same into operation.

This document should be read in conjunction with the Architectural Documentation/ drawings.

This report has been prepared to summarize the minimum performance requirements for each of the façade systems & features as nominated in the Architectural Documentation.

1.2. FT 01 front facade: Structural glass façade with glass fins/mullions (vertical) and glass roof with glass beams (horizontal)

Structural glass facade Z shape in plan FT 01 which consists of a glass façade and a glass roof with sloped/overhead glazing.

The structural supporting system “vertical back-up structure” of the façade glazing is a “Glass – fin/ mullion system” based on a continuous as one piece multi laminated glass fin on which a custom made extruded aluminum profile is structurally bonded. A Glass-fin set perpendicular to the façade glazing at each vertical line of the glass grid.

The horizontal glazing follows the building axis of the new building up to the glass roof of the façade FT 02. Between the existing building and the new building, the horizontal glazing is stored on glass beams. On one side the facade is connected to an existing building. In the floor plan, facade FT 01 has a z-shaped ground plan. Laterally, the facade is connected to existing buildings. The glass façade is made of insulating glass units (IGU) which are stacked to each other for supporting the dead load of the glasses. Also IGUs made of thermally bent glass are intended.

Generally, this façade spans from ground level +0.00 up to +11.86. Shape and dimensions in accordance with drawings.

The silicon joints are to be arranged in such a way at notches and glued points that the structure is sure to be water and airtight. The glass façade and roof design should consider required tolerance for deflection due to design load, wind load, etc.

The glass mullions are to be fixed to the concrete structure via adjustable brackets. The special brackets are to be placed in line with the structure via HALFEN HTA-CE cast-in channels.

All the finish supplied by the specialist structural glass façade contractor must match with the approved coating sample. The external sealant must be UV resistant and black or grey in color.

1.4. External Door Systems

Façade FT 01:

The main entrance on the front façade FT 01 is an all glass revolving door type Crystal Tourniket with three wings and glass ceiling , or equivalent. Constructed virtually completely from glass with only a few stainless steel accents to ensure the solidity of the revolving door. The selected options is Power assist, Positioning Speed Control (PPS).

The second entrance door is a single leaf all glass door, with panic device type fapim Panama or equivalent.

Dimensions in accordance with drawings.

Façade FT 02:

The main entrances on the back façade FT 02 are two double leaf all glass doors with panic device type fapim Panama or equivalent.

Dimensions in accordance with drawings.

1.5. General Drawings

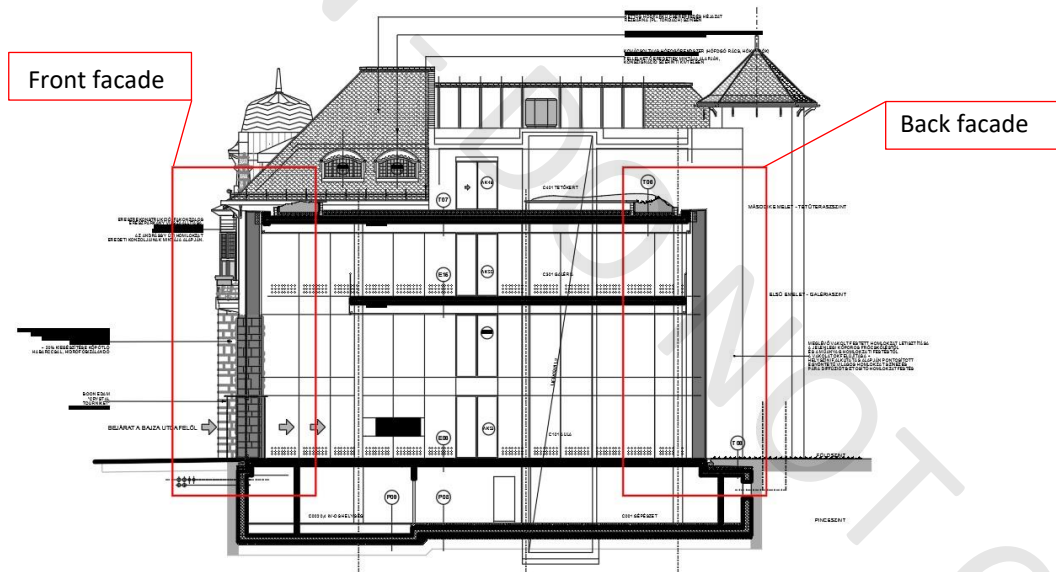
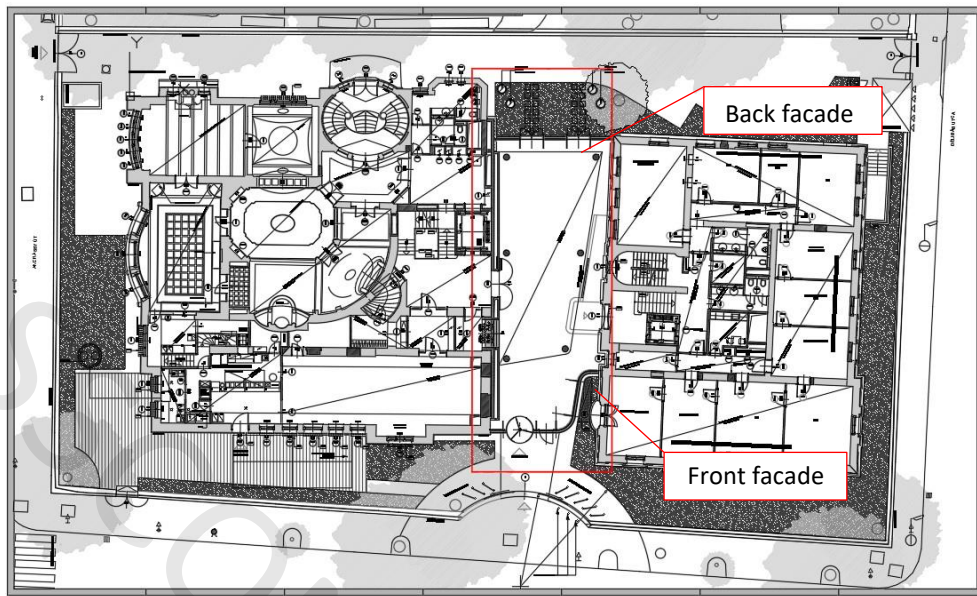

Figure 1. Designated location of the back and front façade in the building of Hungarian Academy of Arts, Budapest, Hungary [1]

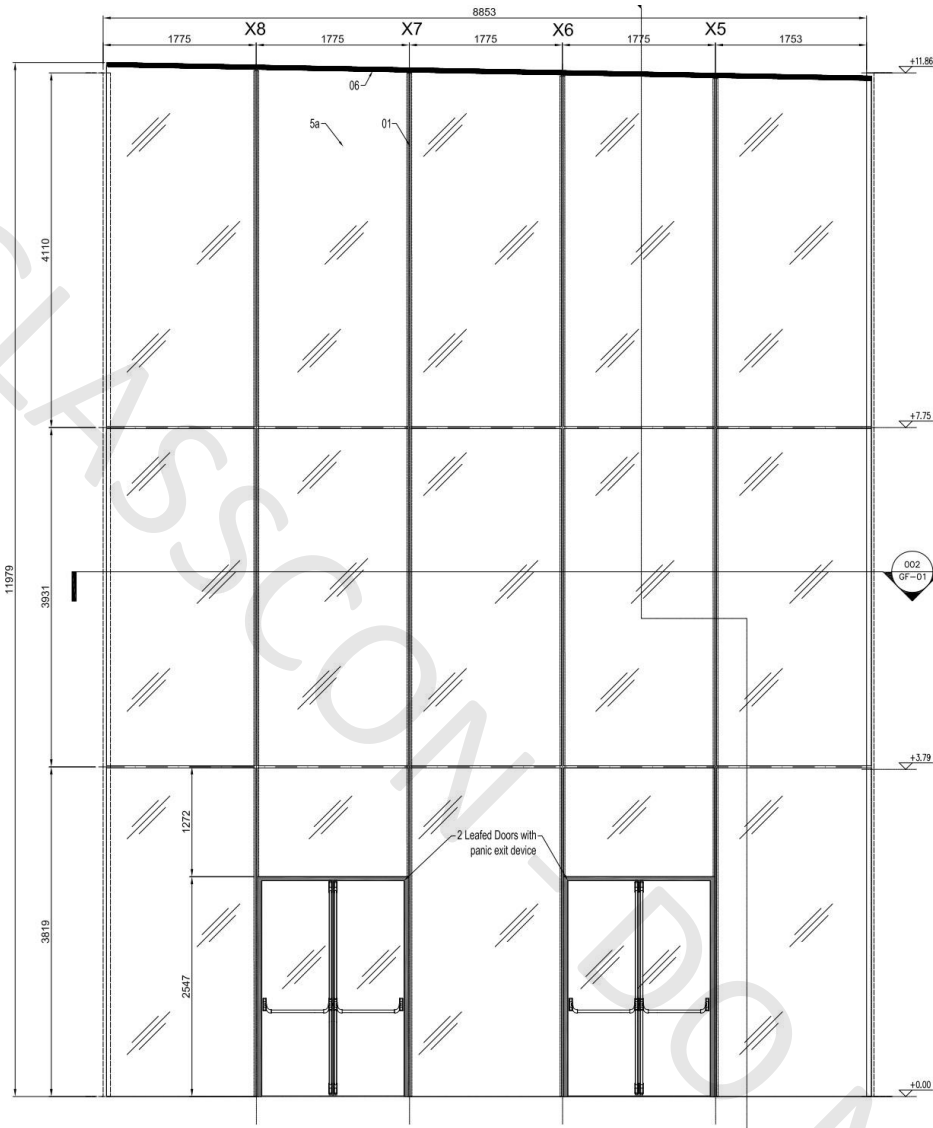

Figure 3. Back Façade of the Hungarian Academy of Arts, Budapest, Hungary [2]

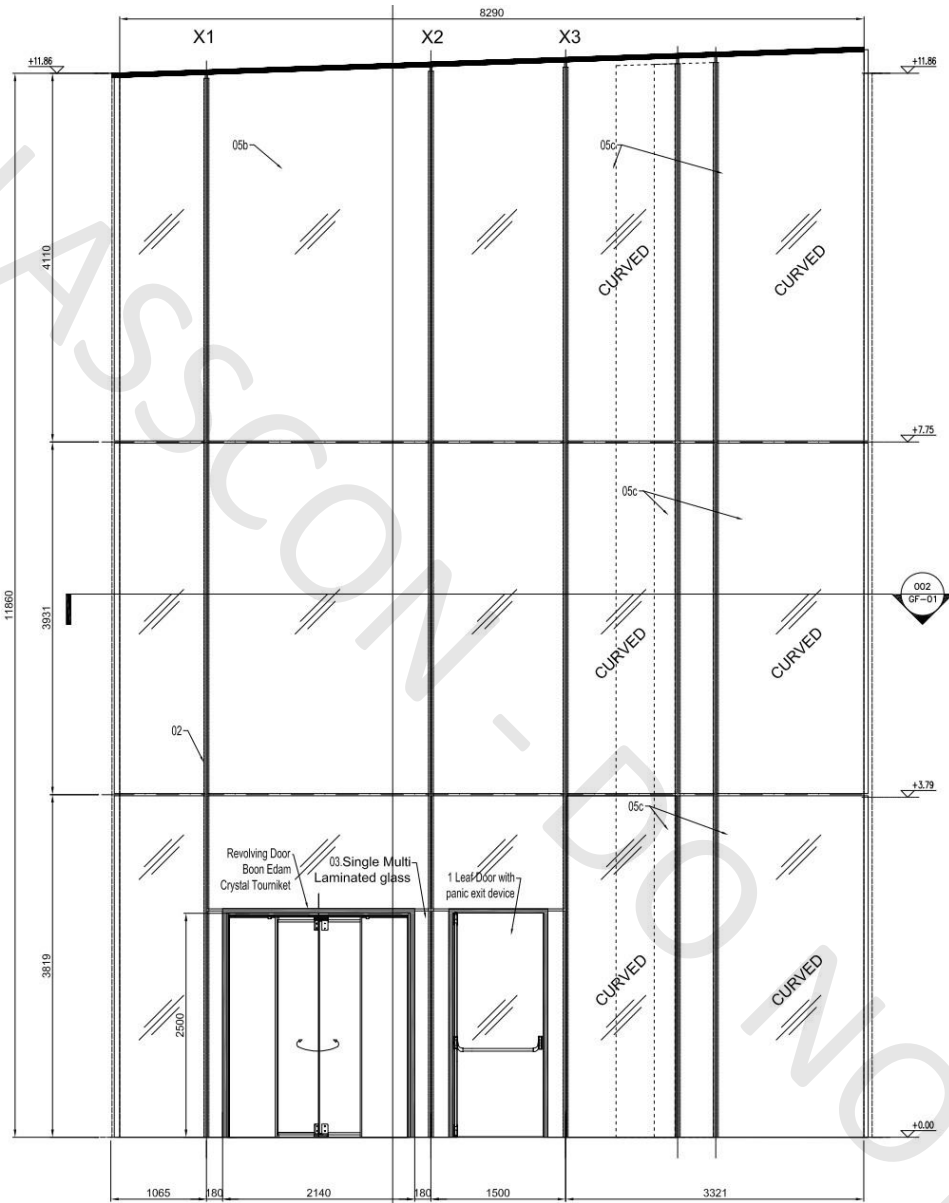

Figure 4. Front Façade of the Hungarian Academy of Arts, Budapest, Hungary [2]

2. Pre-design (Static calculation)

2.1. Glass roof

2.1.1. General

Figure 5. Glass roof

Figure 6. Glass roof (accessible/walkable)

Interior load on inner glass:

Wind suction: $W_{i,s,k}$ = 0.244 kN/m²
chosen = 0.400 kN/m²

Wind pressure: $W_{e,p,k}$ = -0.244 kN/m²
chosen = -0.400 kN/m²

- Snow load

According to EN 1991-3 [5] the following characteristic snow load is considered:

s_k (chosen) = 1.00 kN/m²

- Climatic load

According to DIN 18008 the following climatic loads for the IGU glass type are considered:

- *Summer:*

Difference in temperature
between production and use: $\Delta T = + 20.0 \text{ K}$

Difference in meteorological air pressure between production and use: $\Delta p = - 2.0 \text{ kN/m}^2$

Difference in altitude between production
and use (c.f. Figure 7 and Figure 8): $\Delta H = 0 \text{ m}$

- *Winter:*

Difference in temperature
between production and use: $\Delta T = - 25.0 \text{ K}$

Difference in meteorological air pressure between production and use: $\Delta p = + 4.0 \text{ kN/m}^2$

Difference in altitude
between production and use: $\Delta H = - 50.0 \text{ m}$

This results in an isochoric pressure of + 8.8 kN/m² for the load case summer and of -13.1 kN/m² for the load case winter.

GLASSCON - DO NOT COPY

Figure 7. Altitude production site (source: googlemaps)

Figure 8. Altitude Hungarian Academy of Arts, Budapest (source: googlemaps)

- Live Load (walkable glass)

For maintenance purpose, accessible glazing (according DIN 18008-6 and DIN 4426):

Concentrated load of one person with tools [6] $Q_k = 1.5 \text{ kN}$ (contact area 100 mm x 100 mm)

Walkable glazing (according to DIN 18008-5):

Distributed load [7] q_k $Q_k = 5 \text{ kN/m}^2$
 Concentrated load [7] $Q_k = 1.5 \text{ kN}$
 (contact area 50 mm x 50 mm)

- Load Combination

The loads were combined according to DIN 18008 [8, 9, 10, 11, 12, 6] und EN 1990 [13].

2.1.3. Finite Element Calculations

The numerical analysis was performed with the finite element code SJMEPLA. For the calculation two decisive glass elements, according to their geometry and span width were chosen.

To compare the influence of the bearing, three different finite element models were used for the calculations of these glass elements (c.f. Table 1). For Model A all supports are considered. To show the influence of an failure of the SSG joint and to show the influence of the different stiffness of the support (SSG joint, toggle system) for Model B the SSG joint was not taken into account,. For Model C the linear support to the solid structure of the roof was neglected for lifting loads (wind suction).

Table1 Finite element models for the design of the glass roof

Glass Element	Model	Supported edges	Load
GR1	A	1, 2, 4, 6	all load cases
GR1	B	2, 4, 6	all load cases
GR1	C	1, 2, 6	no snow, no wind suction
GR2	A	1, 3, 7	all load cases
GR2	B	1, 3, 4, 5, 6, 7	all load cases
GR2	C	3, 4, 5, 7	no snow, no wind suction

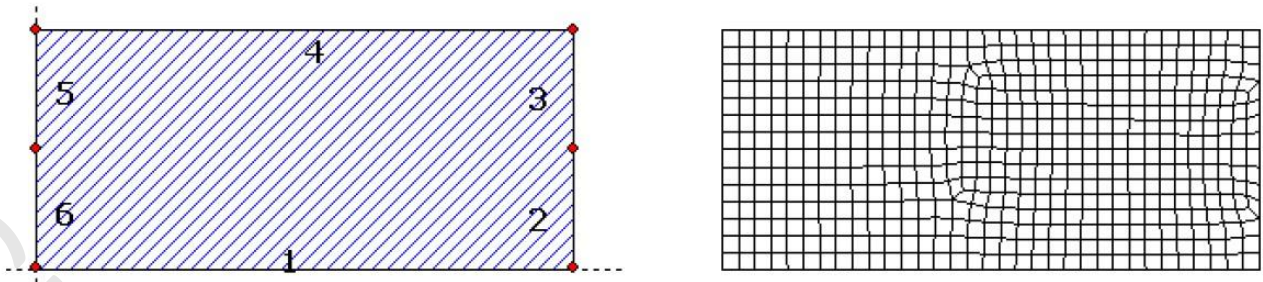

Geometrie:

Rand	Randpunkt		Bogenmitte		Drehrichtung +/-
	mm	mm	mm	mm	
1	0.00	0.00			
2	2700.00	0.00			
3	2700.00	600.00			
4	2700.00	1200.00			
5	0.00	1200.00			
6	0.00	600.00			

Figure 9. Finite element model of GR1

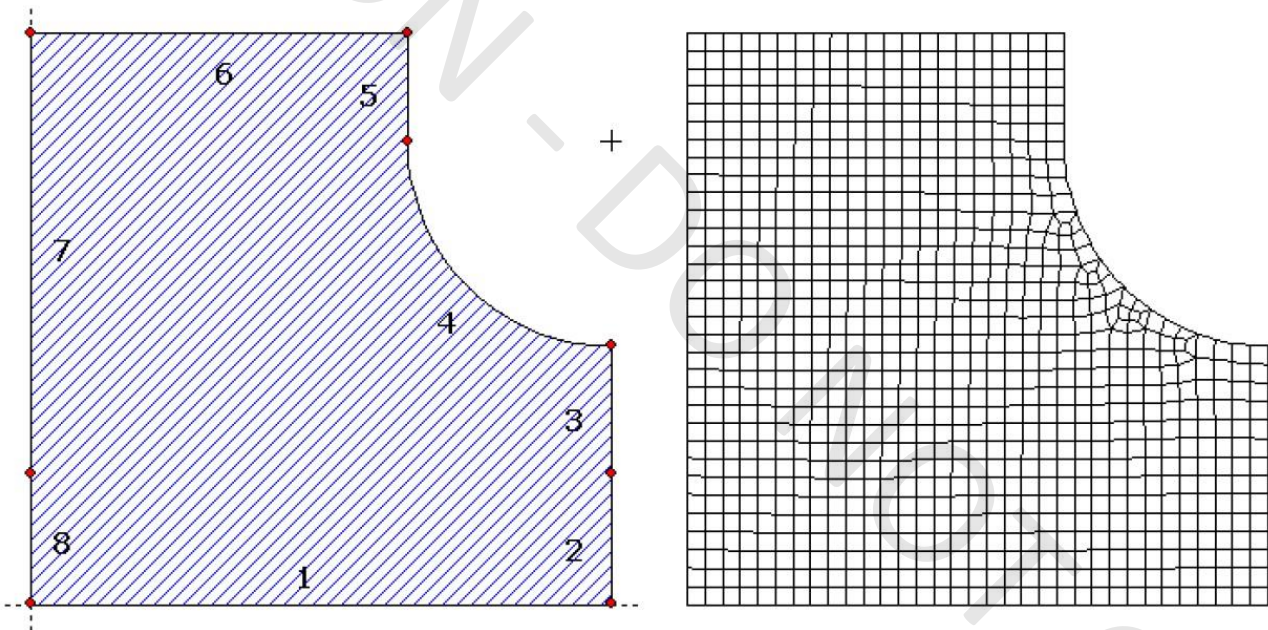

Geometrie:

Rand	Randpunkt		Bogenmitte		Drehrichtung +/-
	mm	mm	mm	mm	
1	0.00	0.00			
2	2700.00	0.00			
3	2700.00	600.00			
4	2700.00	1200.00	2700.00	2150.00	(-)
5	1750.00	2150.00			
6	1750.00	2650.00			
7	0.00	2650.00			
8	0.00	600.00			

Figure 10. Finite element model of GR2

2.1.4. Results

Results of the different finite element calculations are given in Table 2. In Figure 11 and Figure 12 the principal stress distributions are plotted exemplarily. According to the calculations the linear supports parallel to solid structure need to act also for suction loads (c.f. model C). This is also necessary to ensure a structural-physical connection between glass and solid structure (c.f. recommendations in section 8). If a transom profile with pressure plate is used (linear support in and against gravity direction) the allowable stresses are not exceeded. The resulting utilization is between 70% and 100% of the allowable stress. Therefore a thinner glass assembly than mentioned above cannot be recommended.

We recommend to perform experimental component test to verify the dynamic behavior of the glass against soft body impacts as well as the post breakage behavior in case of glass failure according to DIN 18008-5 und DIN 18008-6, if the glass roof shall be accessed for maintenance operations or adjoining traffic areas are not delineated constructional

Table 2. Maximum stress ratio (σ_{Ed}/σ_{Rd}) in the glass roof elements for the ultimate limit state (ULS) and ratio between calculated and allowable deformation (w_{Ek}/w_{Rk}) and serviceability limit state (SLS)

Glass Element	Model	Position	ULS	SLS
GR1	A	1 (ESG)	1,00	0,29
GR1	A	2 (TVG)	0,78	0,22
GR1	A	3 (TVG)	0,78	0,22
GR1	B	1 (ESG)	0,71	1,22
GR1	B	2 (TVG)	0,80	1,07
GR1	B	3 (TVG)	0,80	1,07
GR1	C	1 (ESG)	1,20	1,02
GR1	C	2 (TVG)	1,33	0,89
GR1	C	3 (TVG)	1,32	0,89
GR2	A	1 (ESG)	0,71	0,29
GR2	A	2 (TVG)	0,68	0,23
GR2	A	3 (TVG)	0,67	0,23
GR2	B	1 (ESG)	0,79	0,43
GR2	B	2 (TVG)	0,86	0,37
GR2	B	3 (TVG)	0,86	0,37
GR2	C	1 (ESG)	1,37	0,58
GR2	C	2 (TVG)	1,51	0,50
GR2	C	3 (TVG)	1,50	0,50

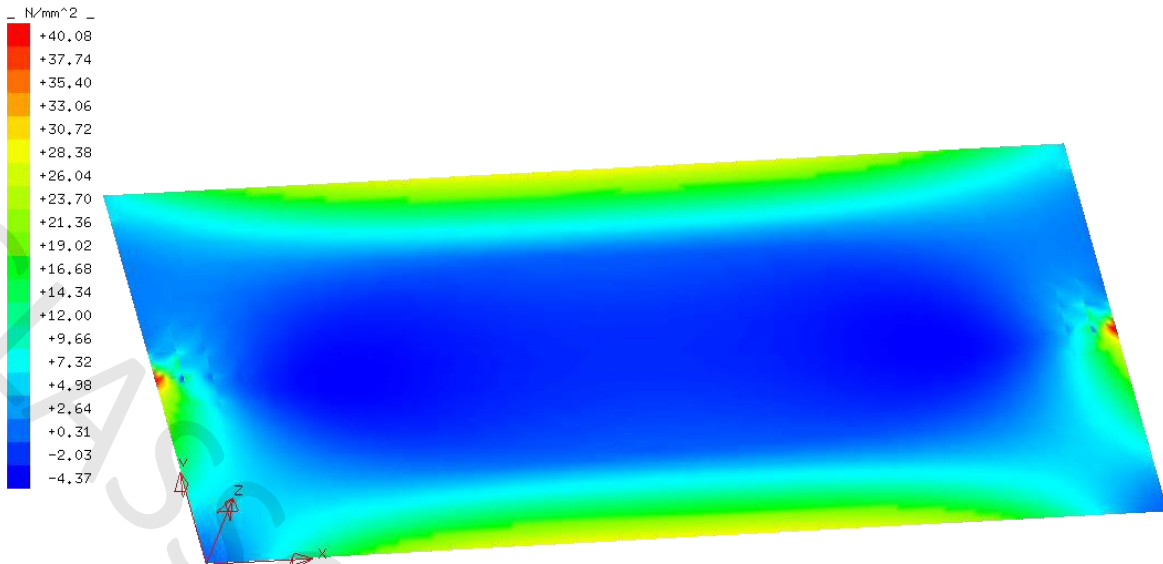

magnification: 1.00

loadcase: 35 package: 1 layer: 1 bottom Sp+

Figure 11. GR1 – maximum principal stress (Model A, Pos. 3)

Figure 12. GR2 – maximum principal stress (Model A, Pos. 2)

Table 3. Reaction forces for the design of the solid construction

Position	Vertical pressure v_p [kN/m]	Vertical suction v_s [kN/m]
front façade	2.8	0.7
back façade	2.8	0.7
between front and back façade	5.5	1.3

2.2. Glass beams (GT1)

2.2.1. General

Figure 13. Schematic view of a glass beam

Figure 14. Schematic cross section of a glass beam

Between both glass facades the horizontal glass roof is supported to horizontal glass beams. The connection between the horizontal glass elements and the beams shall be realized by add on profiles with integrated toggle system. The add-on profile is assembled by an SSG joint to the front end along the longitudinal side of the beams.

For the glass beams the following support conditions can be recommended:

- Supporting the glass beams in steel sockets/sleeves along the front ends of the structural glass elements. The steel sockets are connected directly to the solid structure of the roof and the adjacent building. The principal is shown in the schematic drawing Figure 15.
- Arrangement of two glass drillings at both front ends of the glass beams which are mounted to fittings made of steel. The principal is shown in the schematic drawing Figure 16.

According to [1] the designated assembly of the glass beams is (identical to the glass fins) 5 x 12 mm fully tempered glass with 1.52 mm SG-foil each.

Figure 15. Schematic: support of glass beam with steel sleeve

Figure 16. Schematic: support of glass beam with glass fittings

2.2.2. Load cases

The action on the glass beams results from the support reactions of the horizontal glass units of the roof structure. For the pre-design of the glass beams the following actions are considered.

- Dead Load

The dead load of the glass beams is considered in the finite element calculation by the specification of an acceleration value in gravity direction. The acceleration was set to 9810 mm/s^2 .

The dead load of the roof glazing is considered as uniform linear distributed load: $g_k = 2.7 \text{ m} \times (3 \times 0.015 \text{ m} \times 25 \text{ kN/m}^3) = \underline{3.00 \text{ kN/m}}$

- Wind Load

The wind load on the roof glazing (see section 4.2.2) is considered as uniform linear distributed load:

$$\text{Wind suction: } w_{s,k} = 2.7 \text{ m} \times (0.6 \text{ kN/m}^2 + 0.4 \text{ kN/m}^2) = \underline{2.70 \text{ kN/m}}$$

$$\text{Wind pressure: } w_{p,k} = 2.7 \text{ m} \times (-0.1 \text{ kN/m}^2 - 0.4 \text{ kN/m}^2) = \underline{1.35 \text{ kN/m}}$$

- Snow Load

The snow load on the roof glazing (see section 4.2.3) is considered as uniform linear distributed load:

$$\text{Wind suction: } w_{s,k} = 2.7 \text{ m} \times (1.0 \text{ kN/m}^2) = \underline{2.70 \text{ kN/m}}$$

- Live Load (walkable glass)

For maintenance purpose accessible glazing:

The live load on the for maintenance operations accessible roof glazing (see section 4.2.5) is considered as a point load:

$$Q_k = 1.5 \text{ kN}$$

Walkable glazing:

The live load on the walkable roof glazing (see section 4.2.5) is considered as alternatively acting uniform linear distributed load q_k or point load Q_k in the middle of the glass beam:

$$q_k = 2.7 \text{ m} \times 5.0 \text{ kN/m}^2$$

$$Q_k = 4.0 \text{ kN}$$

- Load Combination

The loads were combined according to DIN 18008 [8, 9, 10, 11, 12, 6] und EN 1990 [13].

- Lateral Buckling

- Failure Scenario

- Shear Transfer of the Interlayer

2.2.3. SSG joint

Figure 17. Connection of roof glazing to glass beam

2.2.4. Finite Element Calculation

For the numerical analysis of the glass beam two models were considered:

- Complete model of the glass beam (global) by which the bending stresses are calculated and stability (lateral buckling) is analyzed.
- Local model by which the influence of a potential support by glass fittings could be analyzed.

The numerical analysis on the local model was performed with the finite element code SJMEPLA. For the support of the model a glass fittings (plate holder, hole) was applied. The position and geometry of the point support was adjusted to the height of the glass beam. The maximum bearing force of the global was applied to the local model. The local model and the meshing are shown in Figure 20.

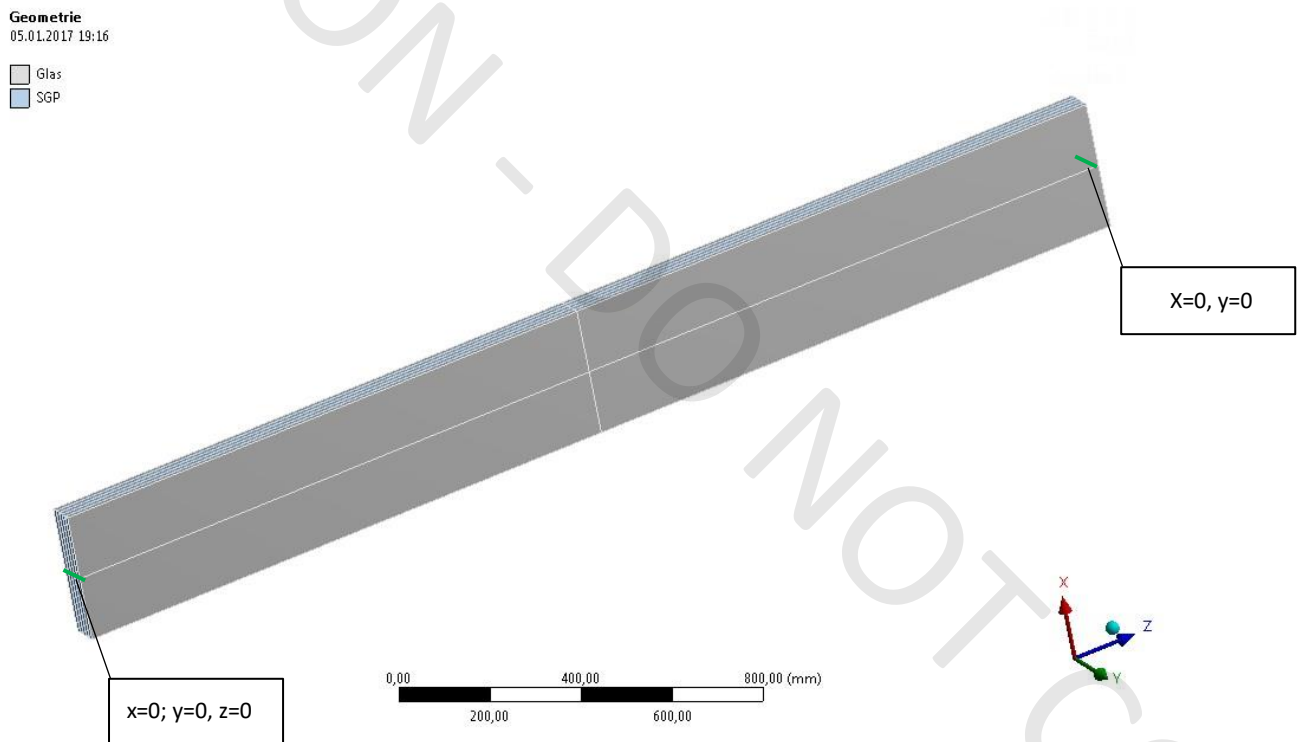
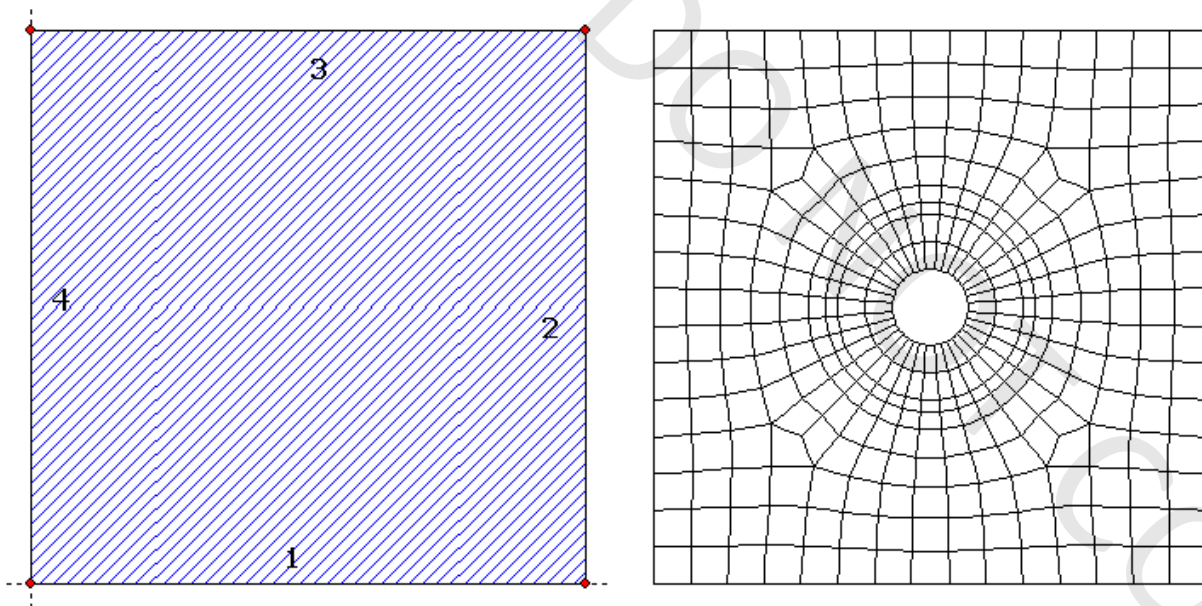

Figure 18. Finite element model of the glass beam (global)

GLASSCON.COM

Figure 19. Meshing of the finite element model of the glass beam (global)

SJMBA Beschränkung:



Geometrie:

Rand	Randpunkt		Bogenmitte		Drehrichtung
	mm	mm	mm	mm	
1	0.00	0.00			
2	150.00	0.00			
3	150.00	150.00			
4	0.00	150.00			

Figure 20. Local finite element model of the glass beam

2.2.5. Results

According to the numerical results the height of glass beams should be chosen as ≥ 150 mm.

In principle, both proposed support types of the glass beams (c.f. Figure 15 and Figure 16) are appropriated. The principal stress utilization at the holes is about 30% of the allowable stress level. The fitting of the glass beam in steel sockets/sleeves along the front ends of the structural glass elements is constructive as well as under static aspects preferred; assembling with point fixings offers the advantage of an undisturbed visibility of the glass elements.

Table 4. Maximum stress ratio (σ_{Ed}/σ_{Rd}) in the glass beams for the ultimate limit state (ULS) and ratio between calculated and allowable deformation (w_{Ek}/w_{Rk}) and serviceability limit state (SLS)

Glass beam height	ULS bending	ULS point fixing	Partial failure	Buckling
150 mm	0,80	0,30	0,96	- / 0,25*
300 mm	0,23	0,30	0,25	0,35 / 0,57*

* Failure scenario

Table 5 Reaction forces for the design of the solid construction

Position	Vertical pressure V_p [kN]	Vertical suction V_s [kN]
between front and back façade	16	-3.1

A: Statisch-mechanische Analyse

Gesamtverformung
Typ: Gesamtverformung
Einheit: mm
Zeit: 1
05.01.2017 18:35

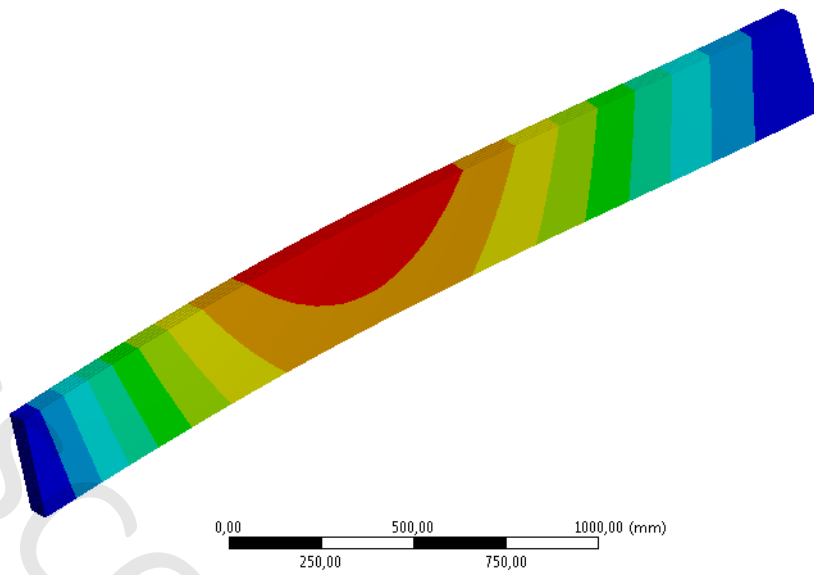
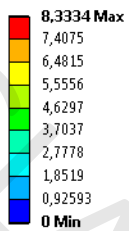

Figure 21. Deformation of the glass beam with a height of 300 mm under full load conditions (ULS) and an induced im- perfection of $1/400 = 6,5$ mm

B: Scheibenausfall

Gesamtverformung
Typ: Gesamtverformung
Einheit: mm
Zeit: 1
05.01.2017 18:33

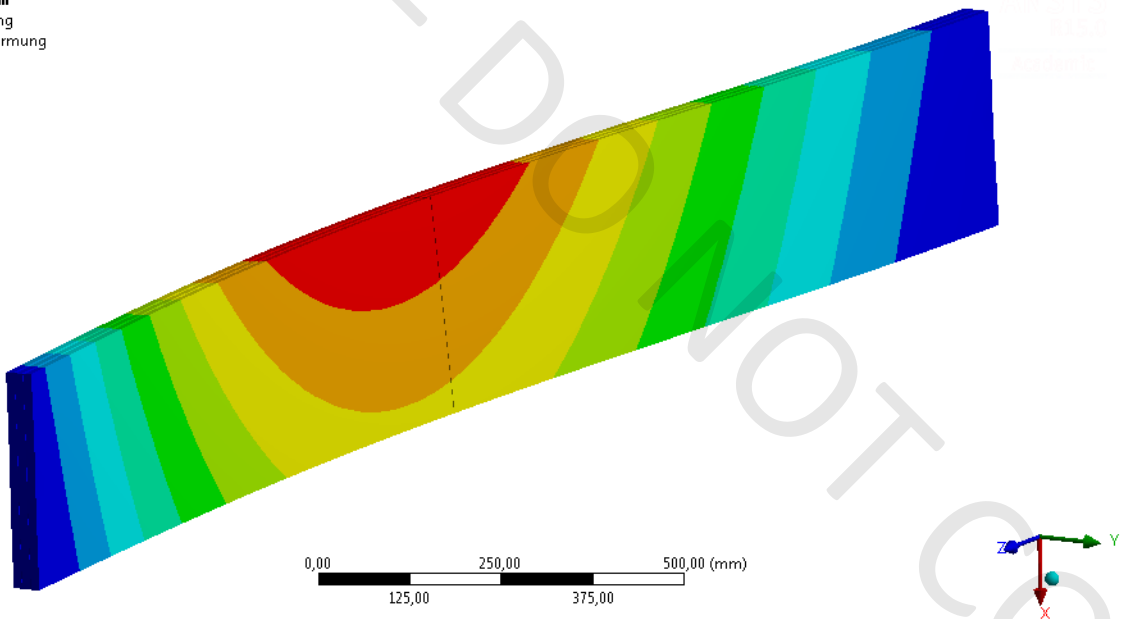
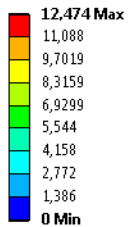

Figure 22. Deformation of the glass beam with a height of 300 mm and partial failure of two glass panes and an induced imperfection of $1/400 = 6,5$ mm

GLASSCON - DO NOT COPY

Figure 23. Principal stress distributions within the local model

2.3. Curtain Wall (GT2, GT3)

2.3.1 General

Besides several plane IGUs, two thermally bent IGUs are designated for the cladding of front and back façade. The load transfer of the IGUs is uniaxial between the adjacent glass fins.

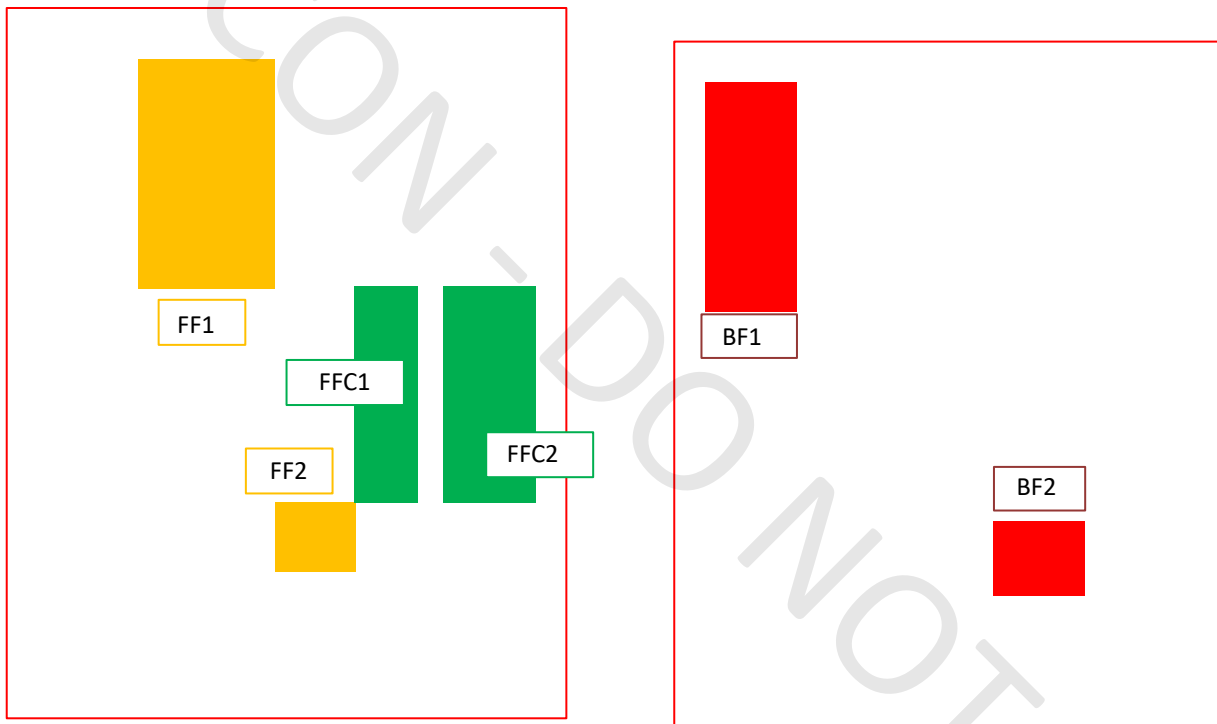

Figure 24. Glass facade

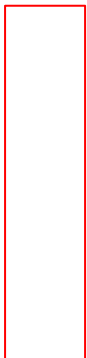

Figure 25. Glass facade

- Climatic Load

The following climatic loads will be considered for the structural analysis (e.g. section 4.2.4):

Summer:

Difference in temperature

between production and use: $\Delta T = + 20.0 \text{ K}$

Difference in meteorological air pressure between

production and use: $\Delta p = - 2.0 \text{ kN/m}^2$

Difference in altitude between production
and use (c.f. Figure 7 and Figure 8):

$\Delta H = 0 \text{ m}$

Winter:

Difference in temperature

between production and use: $\Delta T = - 25.0 \text{ K}$

Difference in meteorological air pressure between
production and use:

$\Delta p = + 4.0 \text{ kN/m}^2$

Difference in altitude

between production and use: $\Delta H = - 50.0 \text{ m}$

- Live Load (walkable glass)

For maintenance purpose, walkable glazing:

Concentrated load of one person with tools [6] (contact
area 100 mm x 100 mm) $Q_k = 1.5 \text{ kN}$

Walkable glazing:

Surface load [7] $q_k = 5 \text{ kN/m}^2$

Concentrated load [7] $Q_k = 1.5 \text{ kN}$

(contact area 50 mm x 50 mm)

- Load Combination

The loads were combined according to DIN 18008 [8, 9, 10, 11, 12, 6] und EN 1990 [13]

- Shear Transfer of the Interlayer

The several glasses of the IGUs are made of laminated safety glass with an SentryGlas (SG) interlayer. For the SG interlayer a general technical approval is available [15], which allows considering a favorable shear transfer. However, on the safe side, in the pre-design a partial shear transfer was neglected. Instead, the situations full shear transfer and no shear transfer were investigated.

2.3.3 Finite Element Model

The numerical analysis of the plane façade glasses were performed with the finite element code SJMEPLA. For the calculation two decisive glass elements for the front and back façade, according to their geometry and span width (minimum size and maximum size) were chosen. The glass elements were supported at the vertical edges. The finite element models are shown in Figure 26 to Figure 29.

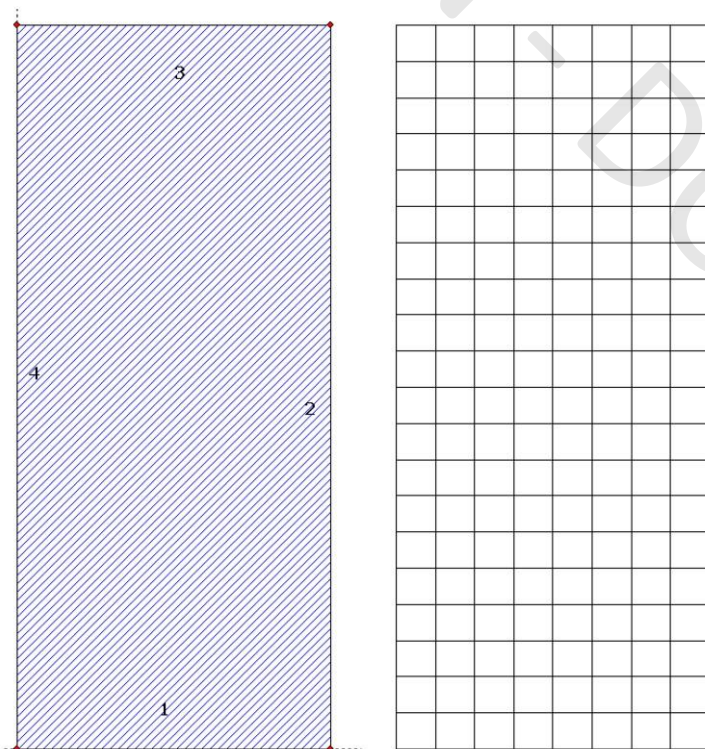

Geometrie:

Rand	Randpunkt mm	Randpunkt mm	Bogenmitte mm	Drehrichtung +/-
1	0.00	0.00		
2	1775.00	0.00		
3	1775.00	4100.00		
4	0.00	4100.00		

Randlager:

Rand	Lagerungsart
2	w : fest - u,v,φ,θ : frei (gelenkig)
4	w : fest - u,v,φ,θ : frei (gelenkig)

Figure 26. Finite element model of BF1

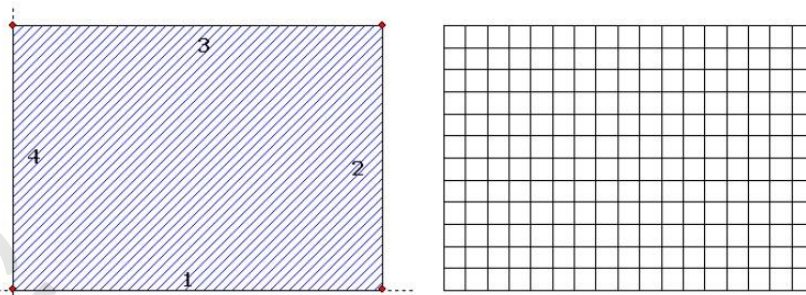

Geometrie:

Rand	Randpunkt		Bogenmitte		Drehrichtung +/-
	mm	mm	mm	mm	
1	0.00	0.00			
2	1775.00	0.00			
3	1775.00	1272.00			
4	0.00	1272.00			

Lager:

Randlager:

Rand	Lagerungsart	
2	w	: fest - u,v,φ,θ : frei (gelenkig)
4	w	: fest - u,v,φ,θ : frei (gelenkig)

Figure 27. Finite element model of BF2

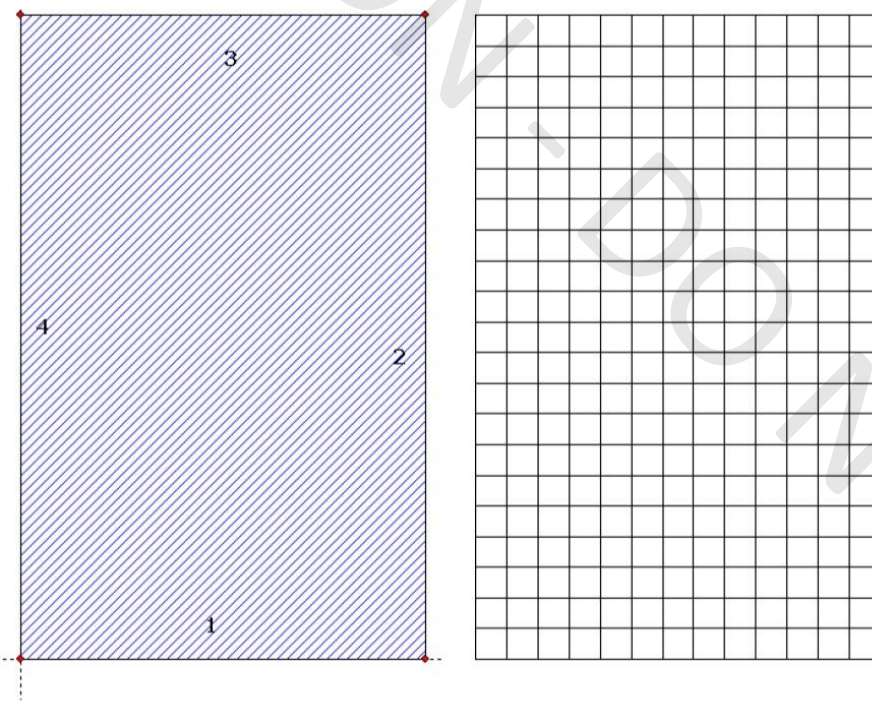

Geometrie:

Rand	Randpunkt		Bogenmitte		Drehrichtung +/-
	mm	mm	mm	mm	
1	0.00	0.00			
2	2700.00	0.00			
3	2700.00	4300.00			
4	0.00	4300.00			

Lager:

Randlager:

Rand	Lagerungsart	
2	w	: fest - u,v,φ,θ : frei (gelenkig)
4	w	: fest - u,v,φ,θ : frei (gelenkig)

Figure 28. Finite element model of FF1

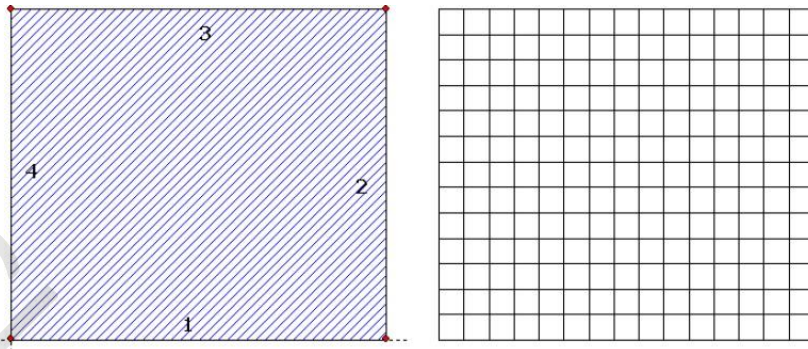

Geometrie:

Rand	Randpunkt		Bogenmitte		Drehrichtung +/-
	mm	mm	mm	mm	
1	0.00	0.00			
2	1500.00	0.00			
3	1500.00	1319.00			
4	0.00	1319.00			

Lager:

Randlager:

Rand	Lagerungsart	
2	w	: fest - u,v,φ,θ : frei (gelenkig)
4	w	: fest - u,v,φ,θ : frei (gelenkig)

Figure 29. Finite element model of FF2

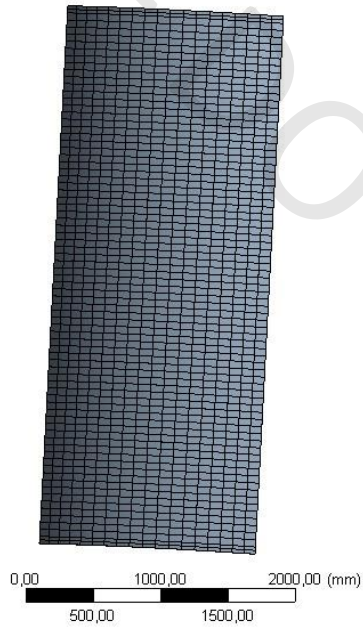

Figure 30. Finite element model of FFC1



Figure 31. Finite element model of FFC2

2.3.4 Results

The glasses should be carried out with an interlayer of SG-foil, which has a significant shear modulus even during long-term loading (here climatic loading) [15]. Accordingly, the real deformation will be significantly lower. For the flat glazing, the planned glass structure can be recommended accordingly.

Table 6. Maximum stress ratio (σ_{Ed}/σ_{Rd}) in the curtain wall elements for the ultimate limit state (ULS) and ratio between calculated and allowable deformation (w_{Ek}/w_{Rk}) for the serviceability limit state (SLS)

The curved façade glazing is planned to be made of thermally bent float glass. The allowable stress is significantly exceeded for the curved glasses. The ratio between calculated and allowable stress is 2.72 (FFC1) and 2.38 (FFC2). In order to absorb these stresses, the bent glasses must be thermally pre-stressed. Assuming the allowable stresses for fully tempered glass, the utilization would be 62 %. The use of thermally toughened glass is recommended only because stacking of the glasses, because the glasses are thus exposed to long-term loading, which leads in float glass to a significant reduction in strength.

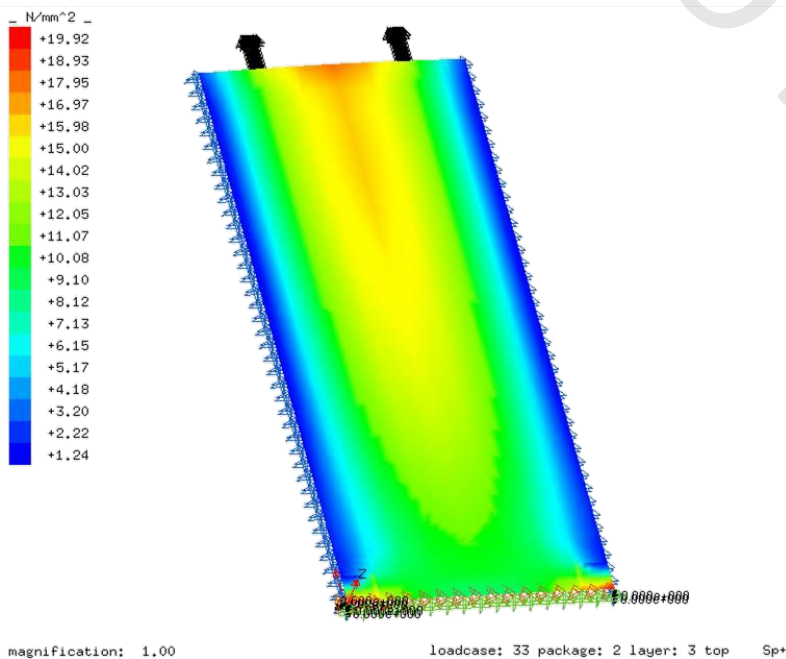

Figure 32. BF1 – maximum principal stress

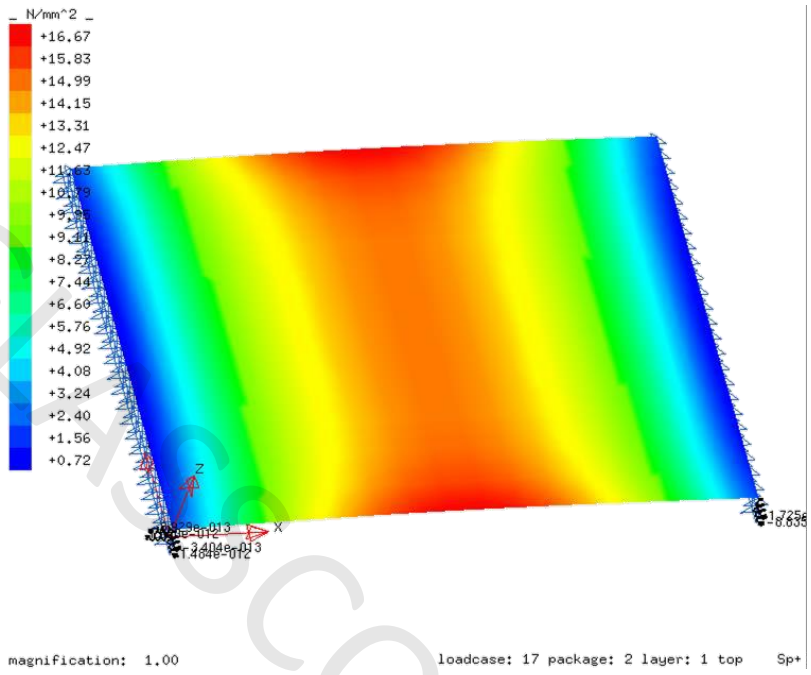

Figure 33. BF2 – maximum principal stress

Figure 34. FF1 – maximum principal stress

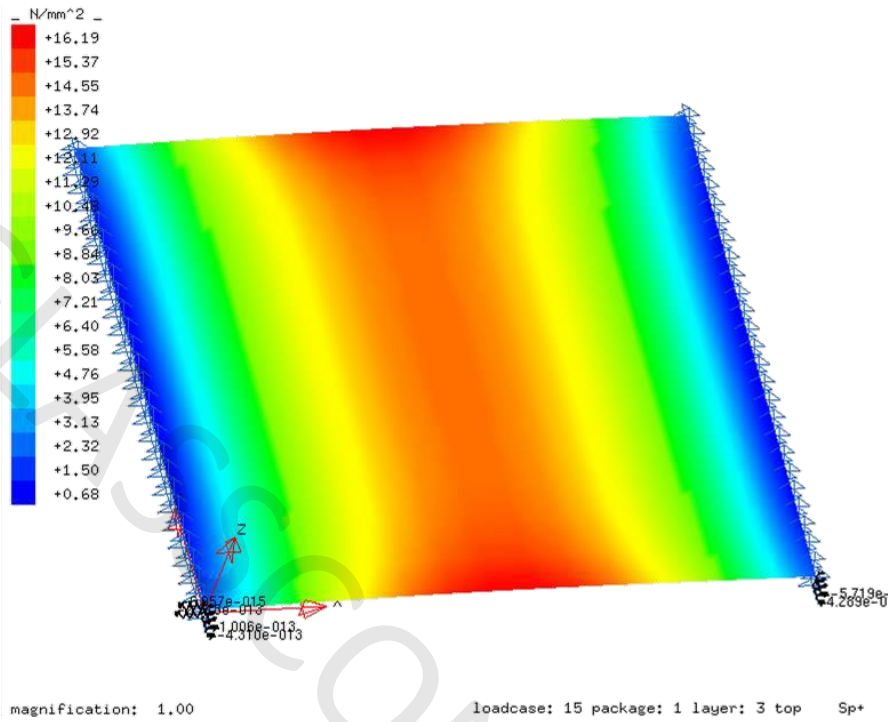

Figure 35. FF2 – maximum principal stress

C: Scheibe 1 (G=2MPa)
 Max. im Hauptachsensystem
 Typ: Max. im Hauptachsensystem
 Einheit: MPa
 Zeit: 1
 06.01.2017 14:30

35,924 Max
 31,819
 27,715
 23,611
 19,507
 15,403
 11,299
 7,1945
 3,0903
 -1,0138 Min

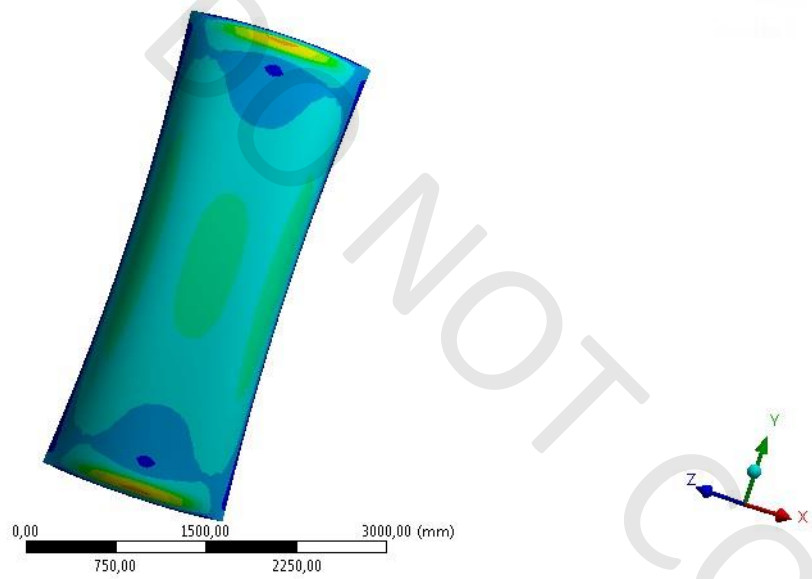

Figure 36. FFC1 – maximum principal stress

C: Scheibe 1 (G=2MPa)
 Gesamtverformung
 Typ: Gesamtverformung
 Einheit: mm
 Zeit: 1
 06.01.2017 14:29

4,3033 Max
 3,8395
 3,3757
 2,9119
 2,448
 1,9842
 1,5204
 1,0566
 0,59276
 0,12894 Min

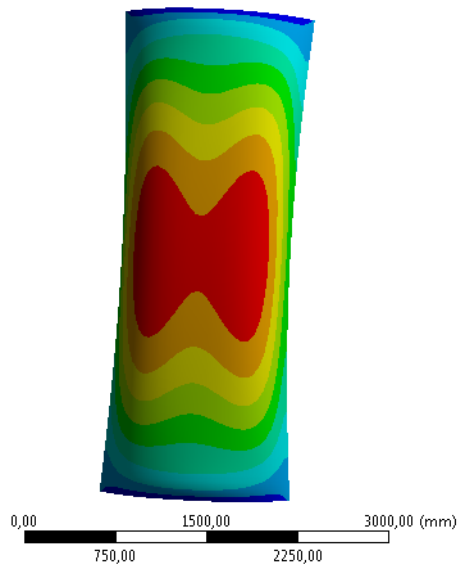

Figure 37. FFC2 – deformation

B: Scheibe 1 (Teilverbund)
 Max. im Hauptachsensystem
 Typ: Max. im Hauptachsensystem
 Einheit: MPa
 Zeit: 1
 06.01.2017 14:36

31,434 Max
 29,156
 26,878
 24,601
 22,323
 20,045
 17,767
 15,49
 13,212
 10,934
 8,6565
 6,3788
 4,101
 1,8233
 -0,45448 Min

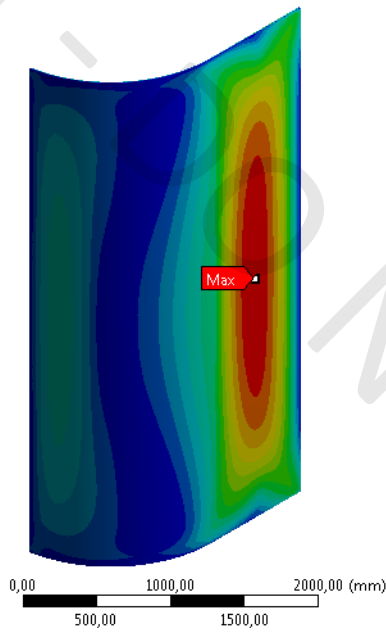
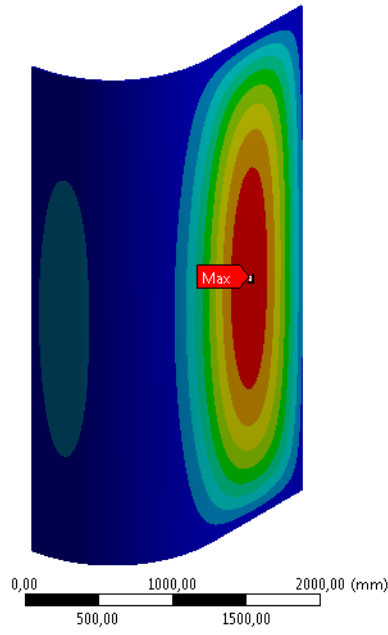
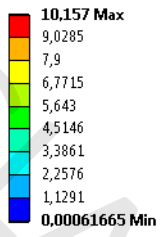

Figure 38. FFC2 – maximum principal stress

B: Scheibe 1 (Teilverbund)
Gesamtverformung
Typ: Gesamtverformung
Einheit: mm
Zeit: 1
06.01.2017 14:36



ANSYS
R15.0
Academic

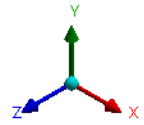

Figure 39. FFC2 –deformation

The dead load of the roof glazing is considered as uniform load:

$$G_k = 0.6 \text{ m} \times 2.7 \text{ m} \times ((2 \times 0.008 \text{ m} + 0.010 \text{ m}) \times 25 \text{ kN/m}^3) = 1.05 \text{ kN}$$

chosen = 2.00 kN

Because of the eccentric load application the following moment is considered:

$$M_k = 2.00 \text{ kN} \times 0.30 \text{ m} = 0.60 \text{ kNm}$$

- Wind Load

The wind load on the curtain wall (see section 6.2.2) is considered as uniform load:

$$\text{Wind suction: } w_{s,k} = 2.7 \text{ m} \times 1.0 \text{ kN/m}^2 = 2.70 \text{ kN/m}$$

$$\text{Wind pressure: } w_{p,k} = 2.7 \text{ m} \times (-1.0 \text{ kN/m}^2) = 2.70 \text{ kN/m}$$

- Snow Load

The snow load on the roof glazing (see section 4.2.3) is considered as uniform load:

$$\text{Snow load: } s_k = 0.6 \text{ m} \times 2.7 \text{ m} \times (1.0 \text{ kN/m}^2) = 1.62 \text{ kN}$$

chosen = 2.00 kN

- Live Load (walkable glass)

According to EN 1991 a horizontal force (parallel to the façade) of 1 kN is applied to the glass fin.

For maintenance purpose, walkable glazing:

The live load on the for maintenance purpose, walkable roof glazing (see section 4.2.5) is considered as point load:

$$Q_k = 1.5 \text{ kN}$$

- Load Combination

The loads were combined according to DIN 18008 [8, 9, 10, 11, 12, 6] und EN 1990 [13].

- Lateral Buckling

imperfection.

- Failure scenario

- Shear Transfer of the interlayer

The glass fins are made of laminated safety glass with a SentryGlass (SG) interlayer. For the SG interlayer a general technical approval is available [14], which allows to consider a favorable shear transfer. According to the approval an appropriate shear modulus of $G = 0.03 \text{ MPa}$ was considered as partial shear transfer for the pre-design of the glass beams. Calculations considering an full shear transfer were performed also.

2.4.3 SSG joint

Figure 41. Connection of roof glazing to glass beam

The add-on-profiles are fixed by an SSG joint to the longitudinal edge of the glass fins. According to the current design, a joint width of $2 \times 18.7 \text{ mm}$ is provided (c.f. Figure 17), which is enough for a continuous linear support but certainly not for the local support by the toggle system. The resulting stress concentration within the SSG joint has to be evaluated in detail by the SSG supplier.

According to ETAG 002 [5], a maximum thickness / width ratio of $1 / 3$ is recommended for SSG joints. The final design of the SSG joints considering the toggle system has to be performed by the SSG supplier.

2.4.4. Finite Element Calculation

For the numerical analysis of the glass fin three models were used:

numerical analysis on the local model was performed with the finite element code SJMEPLA. For the support of the model three glass fittings (plate holder, hole) were applied.

The height of the glass fin was varied in the calculations between 500 mm and 600 mm.

GLASSCON - DO NOT COPY

Figure 42. Simplified framework model of the glass fin

Figure 43. 3D finite element model of the glass fin

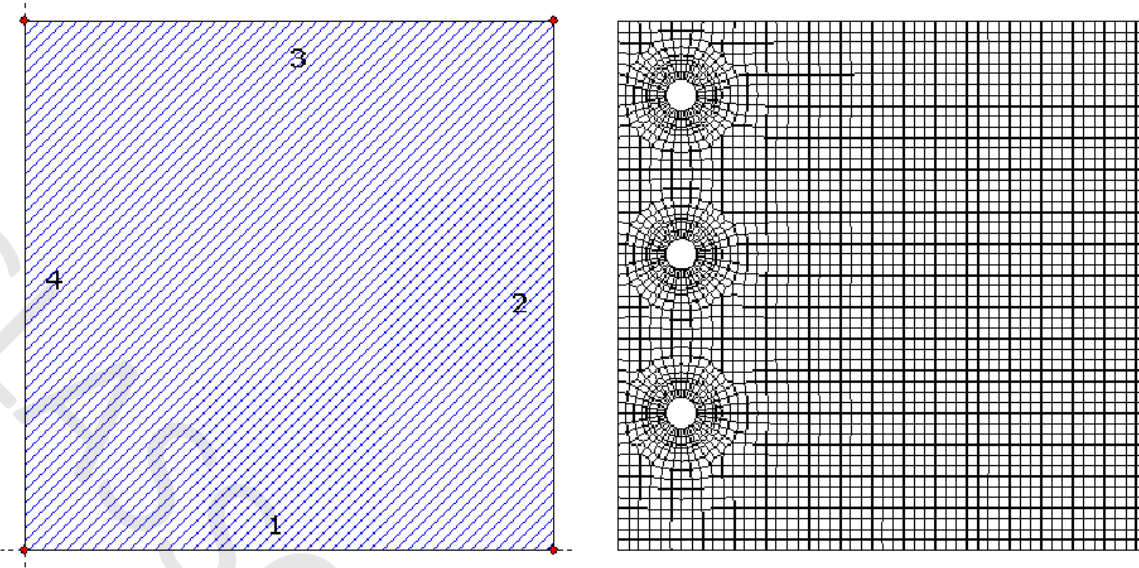

Geometrie:

Rand	Randpunkt		Bogenmitte		Drehrichtung +/-
	ran	ran	ran	ran	
1	0.00	0.00			
2	500.00	0.00			
3	500.00	500.00			
4	0.00	500.00			

Figure 44. Local finite element model of the glass fin

2.4.5 Results

Table 7. Maximum stress ratio (σ_{Ed}/σ_{Rd}) in the glass beam for the ultimate limit state (ULS) and ratio between calculated load and critical buckling load (M_{Rd}/M_{cr})

Glass fin width	ULS bending	ULS point fixing	Partial failure	Buckling
500 mm	0,43	0,14	0,59	+ / +*
600 mm	0,31	0,14	0,44	+ / +*

+ Lateral buckling is not decisive

* Failure scenario

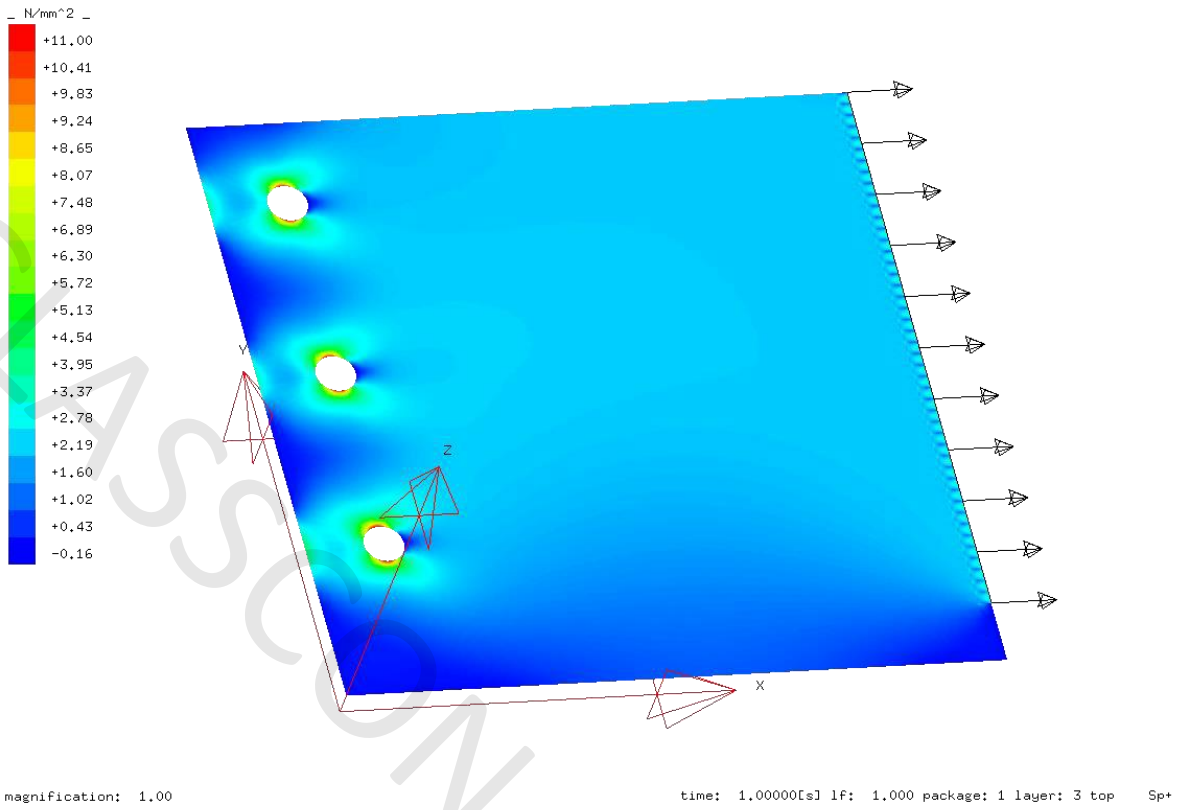

Figure 47. Principal stress distributions within the local model

2.4.6. Support of thermally bent glasses

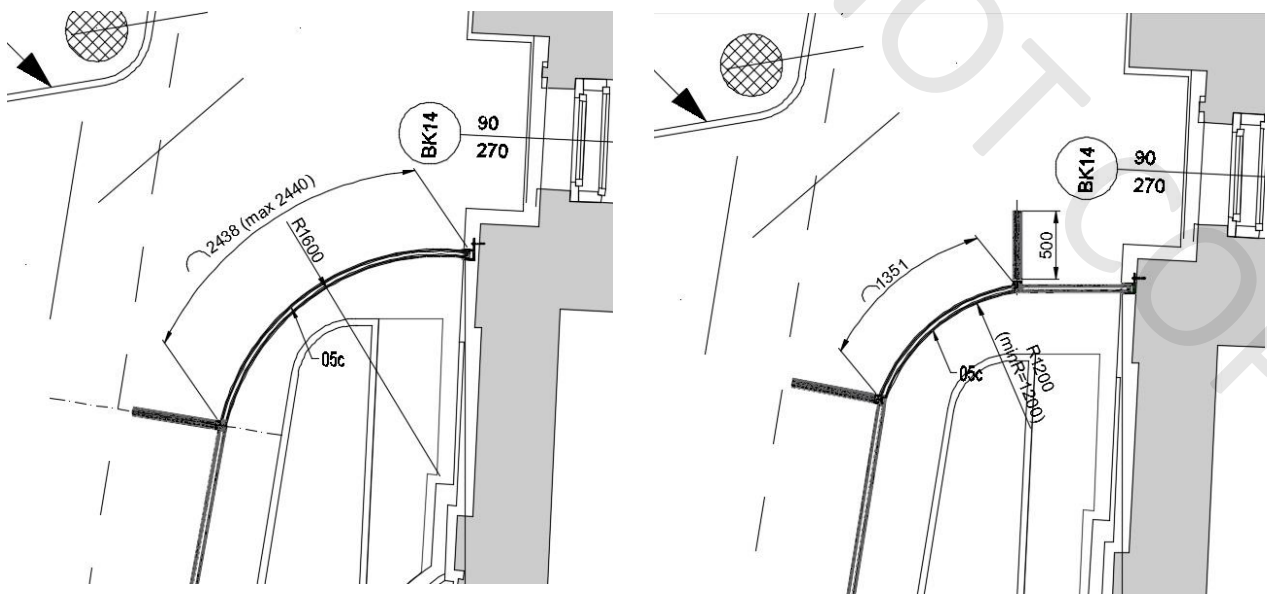

Figure 50 CASE 1 with constant radius

CASE 2 divided in 2 (two) IGUs

5. References

DIN EN 1991-1-4, Eurocode 1: Einwirkungen auf Tragwerke - Teil 1-4: Allgemeine Einwirkungen - Windlasten; Deutsche Fassung EN 1991-1-4:2005 + A1:2010 + AC:2010, Ausgabe Dezember 2010.

DIN EN 1991-1-3, Eurocode 1: Einwirkungen auf Tragwerke - Teil 1-3: Allgemeine Einwirkungen - Schneelasten; Deutsche Fassung EN 1991-1-3:2003 + AC:2009, Ausgabe Dezember 2010.

DIN 18008-6 (Entwurf), Glas im Bauwesen - Bemessungs- und Konstruktionsregeln - Teil 6: Zusatzanforderungen an zu Instandhaltungsmaßnahmen betretbare Verglasungen; Stand Januar 2014.

DIN EN 1991-1-1: Eurocode 1: Einwirkungen auf Tragwerke - Teil 1-1: Allgemeine Einwirkungen auf Tragwerke - Wichten, Eigengewicht und Nutzlasten im Hochbau; Deutsche Fassung EN 1991-1-1:2002 + AC:2009; Ausgabe Dezember 2010.

DIN 18008-1, Glas im Bauwesen - Bemessungs- und Konstruktionsregeln - Teil 1: Begriffe und allgemeine Grundlagen; Ausgabe Dezember 2010.

DIN 18008-2: Glas im Bauwesen - Bemessungs- und Konstruktionsregeln - Teil 2: Linienförmig gelagerte Verglasungen; Ausgabe Dezember 2010.

DIN 18008-3, Glas im Bauwesen - Bemessungs- und Konstruktionsregeln - Teil 3: Punktförmig gelagerte Verglasungen, Ausgabe Juli 2013.

DIN 18008-4, Glas im Bauwesen - Bemessungs- und Konstruktionsregeln - Teil 4: Zusatzanforderungen an absturzsichernde Verglasungen, Ausgabe Juli 2013.

DIN 18008-5, "Glas im Bauwesen - Bemessungs- und Konstruktionsregeln - Teil 5: Zusatzanforderungen an begehbare Verglasungen; Ausgabe Juli 2013".

DIN EN 1990, Eurocode: Grundlagen der Tragwerksplanung, Ausgabe: Dezember 2010.

J. Belis, D. Mocibob, A. Luible and M. Vandebroek, "On the size and shape of initial out-of- plane curvatures in structural," *Construction and Building Materials*, vol. 25, no. 5, pp. 2700- 2712, 2011.

Deutsches Institut für Bautechnik (DIBt), *Allgemeine bauaufsichtliche Zulassung - Z-70.3-170 - Kuraray Europe GmbH - Verbund-Sicherheitsglas aus SentryGlas® 5000 mit Schubverbund*, Berlin, 02.10.2014.

Sika Services AG, Technical Service Report - Joint Calculation Report for Sikasil(R) SG and IG Applications - MMA (Report Number 16/5200 DR1), Tuffenwies/Switzerland, 12.10.2016.

ETAG 002, Guideline for european technical approval for Structural sealant glazing kits (SSGK), Mai 2012.

EOTA, European Technical Approval 03/0038 - Sikasil SG 500, 16.03.2014.

QUALICOAT Specifications for the Quality Label for Liquid and Powder Organic Coatings on Aluminum for Architectural Applications